

## Miniature Circuit Breakers and Switch Disconnectors

**FEATURES**

- AS 3111 approved (Approval No. N15215)
- Available in single, double, triple pole and four pole units
- Precision circuit breaker utilizing hydraulic magnetic technology results in accurate temperature independent tripping
- IP2X “finger proof” line and load box (tunnel) type terminals can accommodate copper cables up to 50mm<sup>2</sup>
- Clear positive identification for ON/OFF (I/O) provided
- Shunt trip provides for remote tripping
- Auxiliary switch provides for remote indication

**APPLICATIONS**

- The SFM series of miniature circuit breakers provides circuit and equivalent protection for 240/415V AC and 125/250V DC systems
- Protection of cables, lighting, appliances, motors and general commercial, industrial and mining equipment

# HEINEMANN ELECTRIC PTY LTD

A member of the **GBi**electric group  
low voltage

**HEINELEC**<sup>®</sup>  
CIRCUIT PROTECTION

E-mail: [heinelec@heinelec.com.au](mailto:heinelec@heinelec.com.au) Website: [www.heinmannelectric.com.au](http://www.heinmannelectric.com.au)

## Miniature Circuit Breakers and Switch Disconnectors

### TECHNICAL DATA

PRODUCT TYPE:	SFM SERIES
Number of poles:	1, 2, 3, and 4 pole.
Standards:	AS 3111
Approval Number:	N15215
Standard Ampere Rating:	2,4,6,10,16,20,25,32,40,50,63,80,100A
Rated Voltage (Un): AC	1 pole 240V 2, 3 & 4 pole 415V
DC	1 pole 125V 2 pole 250V 3 pole 480V
Frequency:	50/60Hz for AC forms
Rated Breaking Capacity (kA):	6kA at 415/240V AC 5kA at 125V DC (1 pole) 3kA at 250V DC (2 pole) 1.5kA at 480V DC (3 pole)
Rated Impulse Withstand Voltage (Uimp):	6kV
Time Current Characteristics:	Curve 1 (Long) : (similar to Curve D) Curve 2 (Medium) : (similar to Curve C) Curve 3 (Short) :
Operating temperature:	-10 to +60°C
Storage temperature:	-20 to +60°C
Degree of Protection:	IP2X terminals
Rated Service Life (AC):	6000 electrical operations 4000 mechanical operations
Humidity:	To Mil-Std-202G Method 103B test condition A
Shock:	Single pole conforms to 50G shock at 6ms, when tested to Mil-Std-202G Method 213B test condition 1
Vibration:	Single pole conforms to Mil-Std-202G Method 204D test condition A It also conforms to IEC577, which is applicable to rolling stock
Mounting:	Surface, cliptray or front screws (M4)
Terminal connections:	Front connected box (tunnel) type main terminal suitable for up to 50mm <sup>2</sup> copper conductors (4Nm torque) Front connected screw type terminal suitable for up to 50mm <sup>2</sup> lugs (4Nm torque). Back/Rear connected stud type terminal fitted with M6 studs (2.5Nm torque)
Handle colour:	White – curve 2/3 circuit breaker AC Orange – curve 1 circuit breaker AC Blue – circuit breaker DC Green – switch disconnector (non-auto)

## Miniature Circuit Breakers and Switch Disconnectors

### TECHNICAL DATA

#### SFM CATALOGUE NUMBER

The catalogue number for any non-standard SFM miniature circuit breaker is created using the details contained in the tables below. The breaker is created from the left hand pole as viewed from the front of the panel.

#### Determine the following information:

1. Frame type
2. Number of poles (1, 2, 3 or 4)
3. Frequency and terminal configuration from table A
4. Internal circuit from table B
5. Current rating and time delay curve

The catalogue number consists of the following information:

Frame type & number of poles, terminal configuration and internal circuit, amp rating and the curve type.

The generic layout is as follows: SFMX-X-X-X

Frame Type and No. of Poles	Frequency, Terminal Configuration and Internal Circuit	Amp Rating	Curve Type
SFMX	X	X	X

Table A:		Table B:	
Code	Frequency and Terminal Configuration	Code	Internal circuit
<b>A</b>	50/60Hz back connected stud type main terminal	<b>0</b>	Switch disconnector (non-auto)
<b>G</b>	50/60Hz front connected box (tunnel) type main terminal	<b>1</b>	Overload with back connected auxiliary switch
<b>D</b>	50/60Hz front connected screw type main terminal	<b>3</b>	Overload
<b>B</b>	DC back connected stud type main terminal	<b>10</b>	Shunt-trip (ST1), flexible leads Occupies additional pole (non-auto pole included)
<b>H</b>	DC front connected box (tunnel) type main terminal	<b>11</b>	Shunt-trip (ST1) with back connected auxiliary switch Occupies additional pole (non-auto pole included)
<b>E</b>	DC front connected screw type main terminal	<b>13</b>	Switch disconnector (non-auto) with back connected auxiliary switch
		<b>14</b>	Shunt trip and series cut-off switch (ST1CO) with flexible leads Occupies additional pole (non-auto pole NOT included)
		<b>15</b>	Auxiliary switch with flexible leads.

**Example:** The following catalogue number depicts a 3 pole, 100A AC, Curve1, with front connected screw type main terminals: **SFM3-D3-100-1**

## Miniature Circuit Breakers and Switch Disconnectors

### FACTORY FITTED OPTIONS

#### Shunt Trip

The shunt trip is used for remote tripping of the circuit breaker. The shunt trip occupies the width of a single pole SFM (26mm) and is mechanically linked to an adjacent circuit breaker but is electrically isolated from it. The shunt trip pole is located to the left of multi-pole units when viewed from the front, with flexible leads (0.2mm<sup>2</sup> x 600mm) that exit below the 'load side' terminal and is rated at 24V to 250V AC and 12V to 125V DC.

The shunt trip is available in two configurations ST1 and ST1CO (shunt trip with cut-off switch):

- **Option 1: ST1 (Code 10)**  
Factory fitted, integral within a non-auto pole with flexible leads out. The shunt trip coil is short time rated.
- **Option 2: ST1CO (Code 14)**  
Factory fitted, additional pole occupies the width of a single pole with flexible leads out (non-auto pole NOT included). Shunt trip coil is wired in series with integral cut-off switch.

#### Auxiliary Switch

Auxiliary switch is used to provide remote indication for the position of the main contacts (Provides the circuit breaker status).

The single pole double throw (SPDT) auxiliary switch is rated at 3A 250V AC resistive and 2A 30V DC resistive and is available in two configurations:

- **Option 1: (Codes 1, 11 and 13)**  
Factory fitted, integral within MCB or Non-Auto pole. Rear mounted, with quick connect terminals (0.8 x 6.3mm).
- **Option 2: (Code 15)**  
Factory fitted, additional pole occupies the width of a single pole and is mechanically linked to an adjacent circuit breaker but is isolated from it. The auxiliary switch is located to the right of multi-pole units when viewed from the front. Flexible leads (0.2mm<sup>2</sup> x 600mm) exit below 'load side' terminal.

#### Handle Interlock

Mechanically interlocks the operating handles of 2, 3 or 4 pole breakers. Occupies an additional pole situated between the two circuit breakers, which are required to be interlocked. Catalogue number: SFMHI.



Handle Interlock

### ACCESSORIES

#### Handle Lock

Permits padlocking of the operating handle in the off position to ensure safety during lockout, when maintenance is being conducted. The handle lock accepts padlocks with hasps up to 8mm in diameter.



SFM with handle lock

Miniature Circuit Breakers and Switch Disconnectors

**TECHNICAL DATA**

**PHYSICAL DIMENSIONS** (shown in millimetres)

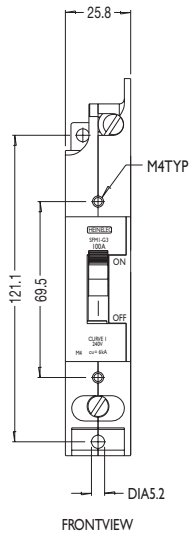

FRONTVIEW

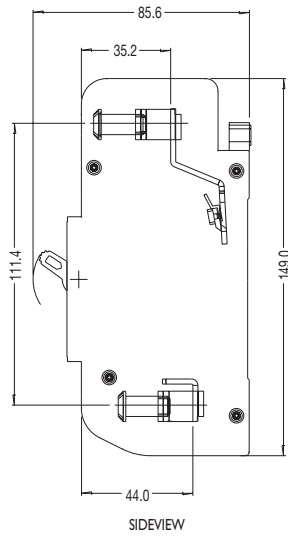

SIDEVIEW

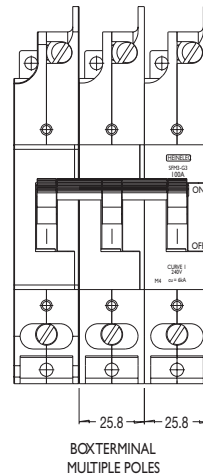

BOXTERMINAL  
MULTIPLE POLES

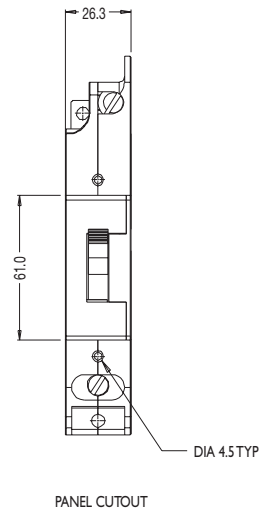

PANEL CUTOUT

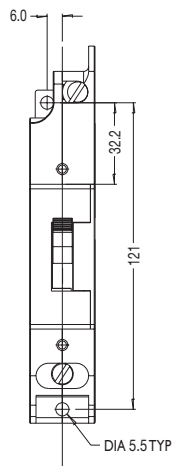

SURFACE MOUNT  
DRILL PLAN

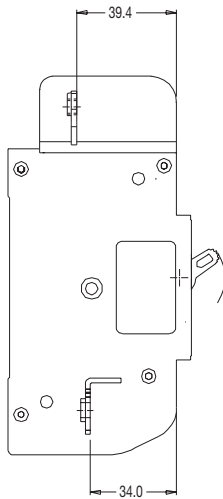

FRONT CONNECTED  
SCREWTERMINAL

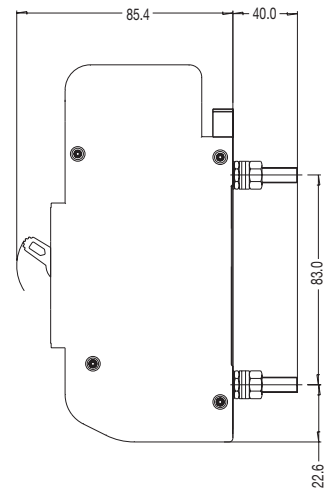
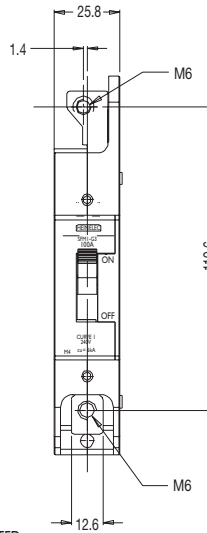

SIDEVIEW BACK CONNECTED STUDS

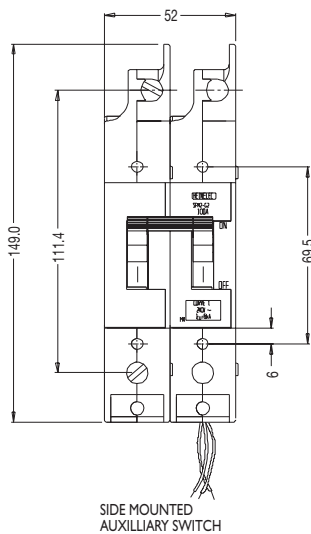

SIDE MOUNTED  
AUXILLIARY SWITCH

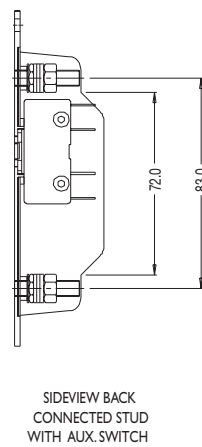

SIDEVIEW BACK  
CONNECTED STUD  
WITH AUX. SWITCH

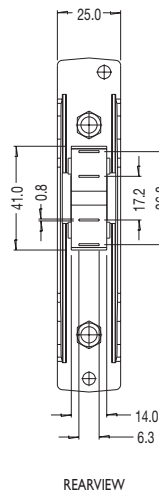

REARVIEW

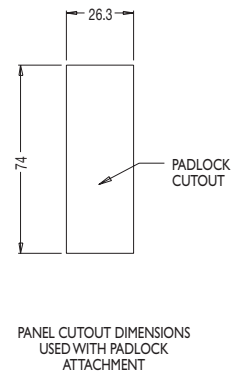

PANEL CUTOUT DIMENSIONS  
USED WITH PADLOCK  
ATTACHMENT

## Miniature Circuit Breakers and Switch Disconnectors

### SELECTION DATA

#### Circuit breaker selection for motor circuits: D.O.L. starting

240V 50Hz SINGLE PHASE HEINELEC Breaker Curve & Current Rating				
Full Load Current	Approx Motor kW	SFM1 (1) Curve 2 (Std)	SFM1 (2) Curve 1	Approx Motor H.P.
1.8	0.12	10	4	1/6
2.7	0.18	10	4	1/4
3.0	0.25	10	4	1/3
4.0	0.37	16	10	1/2
4.8	0.37	16	10	1/2
5.2	0.55	16	10	3/4
6.3	0.75	20	10	1
8.0	1.1	25	16	1-1/2
10.0	1.5	32	16	2
14.5	2.2	40	20	3
18.5	3.0	50	32	4
24.0	3.7	63	40	5
33.0	5.5	80	50	7-1/2

415V 50Hz 3 PHASE HEINELEC Breaker Curve & Current Rating				
Full Load Current	Approx Motor kW	SFM3 (1) Curve 2 (Std)	SFM3 (2) Curve 1	Approx Motor H.P.
1.0	0.37	4	4	1/2
1.5	0.55	6	4	
2.0	0.75	10	4	1
3.0	1.1	16	6	1-1/2
4.0	1.5	16	10	2
5.0	2.2	16	10	3
6.0		20	10	
7.0	3.0	20	16	4
8.0	3.7	25	16	5
9.0	4.0	25	16	6
10		32	16	
11	5.5	32	16	7-1/2
12		40	16	
13		40	20	
14		40	20	
15	7.5	50	20	10
16		50	25	
17-20	10	63	32	12-1/2
21-22	11	63	32	15
23-26		80	40	
27-28	15	80	40	20
29-31		100	50	
32-36	18.5	100	50	25
37-44	22		63	30
45-51	25		80	35
52-56	30		80	40
57-60	34		80	45
61-68	37		100	50
69-72			100	
73-80	45			60

- (1) Selection is based on holding 125% of F.L.C. continuously irrespective of ambient temperature and 600% of F.L.C. for a minimum of 5 seconds for D.O.L. starting. (350% & 12 seconds for reduced current). Provides short circuit, locked rotor and overload protection above 250% of motor F.L.C.
- (2) Selection is based on holding 125% of F.L.C. continuously irrespective of ambient temperature and 600% of F.L.C. for a minimum of 5 seconds for D.O.L. starting. (350% & 12 seconds for reduced current). Provides short circuit, locked rotor and overload protection above 200% of motor F.L.C.

## Miniature Circuit Breakers and Switch Disconnectors

**SELECTION DATA**

Circuit breaker selection for motor circuits: Star Delta, Auto-transformer, Resistor or Reactance starting

415V 50Hz 3 PHASE HEINELEC & HEIDIN Breaker Curve & Current Rating				
Full Load Current	Approx Motor kW	SFM3 (1) Curve 2 (Std)	SFM3 (2) Curve 1	Approx Motor H.P.
1.5	0.55	4	4	
2.0	0.75	6	4	1
3.0	1.1	10	6	1-1/2
4.0	1.5	10	6	2
5.0	2.2	16	10	3
6.0		16	10	
7.0	3.0	20	10	4
8.0	3.7	20	16	5
9.0	4.0	25	16	6
10		25	16	
11	5.5	32	16	7-1/2
12		32	16	
13		32	20	
14		32	20	
15	7.5	40	20	10
16		40	25	
17-20	10	50	32	12-1/2
21-22	11	63	32	15
23-26		63	40	
27-28	15	63	40	20
29-31		80	50	
32-36	18.5	80	50	25
37-44	22		63	30
45-51	25		80	35
52-56	30		80	40
57-60	34		80	45
61-68	37		100	50
69-72			100	
73-80	45		100	60

- (1) Selection is based on holding 125% of F.L.C. continuously irrespective of ambient temperature and 600% of F.L.C. for a minimum of 5 seconds for D.O.L. starting. (350% & 12 seconds for reduced current). Provides short circuit, locked rotor and overload protection above 250% of motor F.L.C.
- (2) Selection is based on holding 125% of F.L.C. continuously irrespective of ambient temperature and 600% of F.L.C. for a minimum of 5 seconds for D.O.L. starting. (350% & 12 seconds for reduced current). Provides short circuit, locked rotor and overload protection above 200% of motor F.L.C.

Miniature Circuit Breakers and Switch Disconnectors

**SELECTION DATA**

Time Current Characteristics

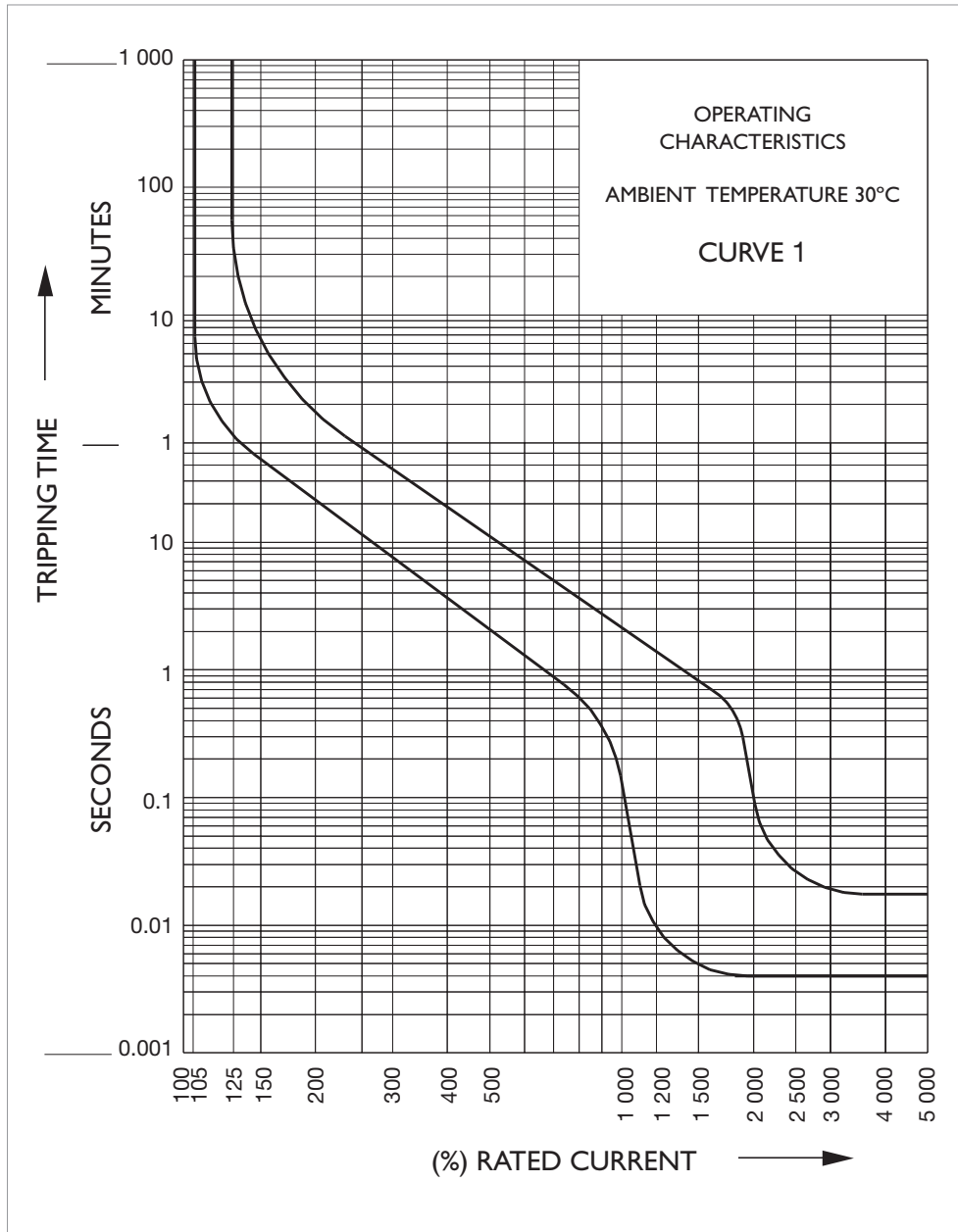

Miniature Circuit Breakers and Switch Disconnectors

**SELECTION DATA**

**Time Current Characteristics**

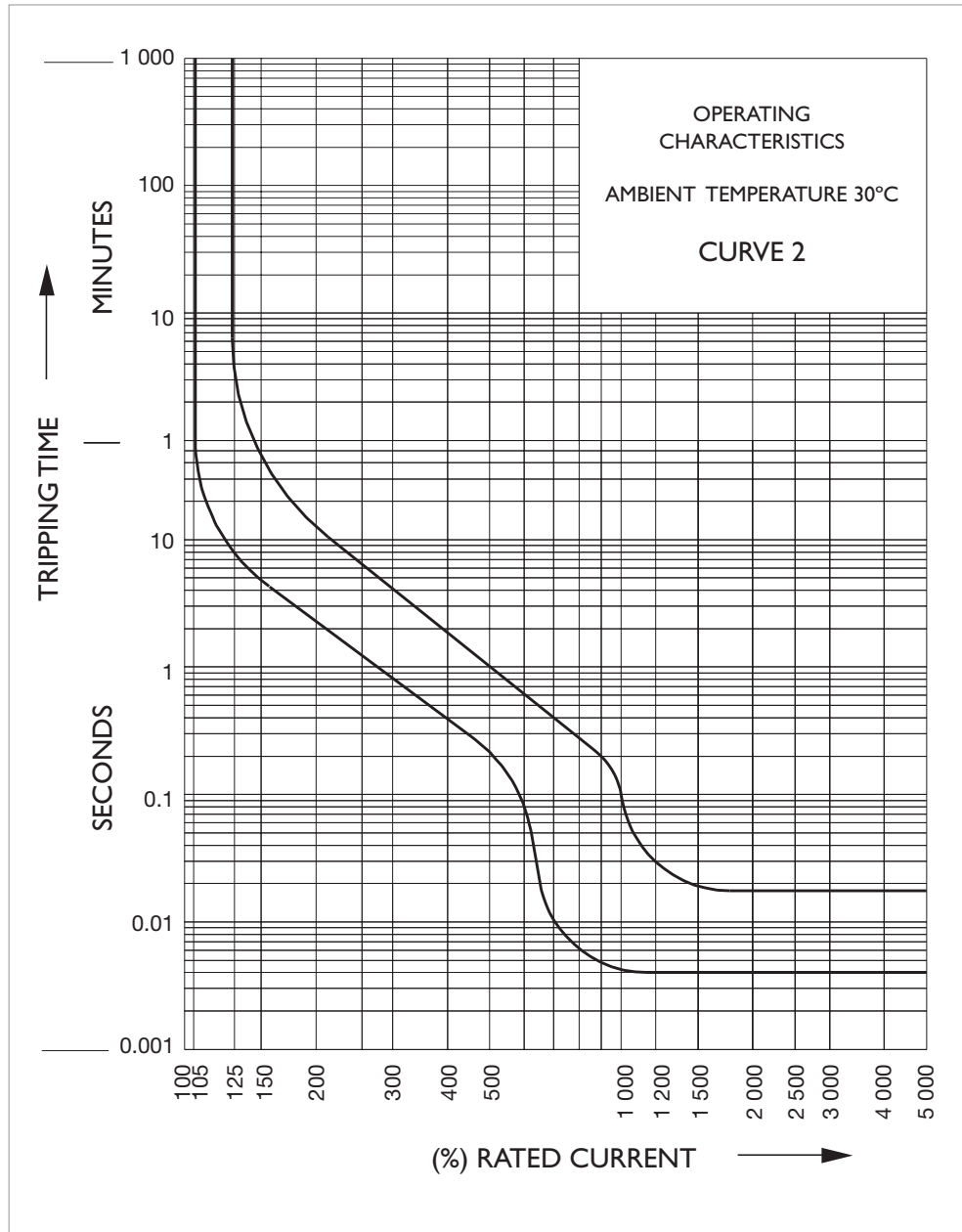

Miniature Circuit Breakers and Switch Disconnectors

**SELECTION DATA**

Time Current Characteristics

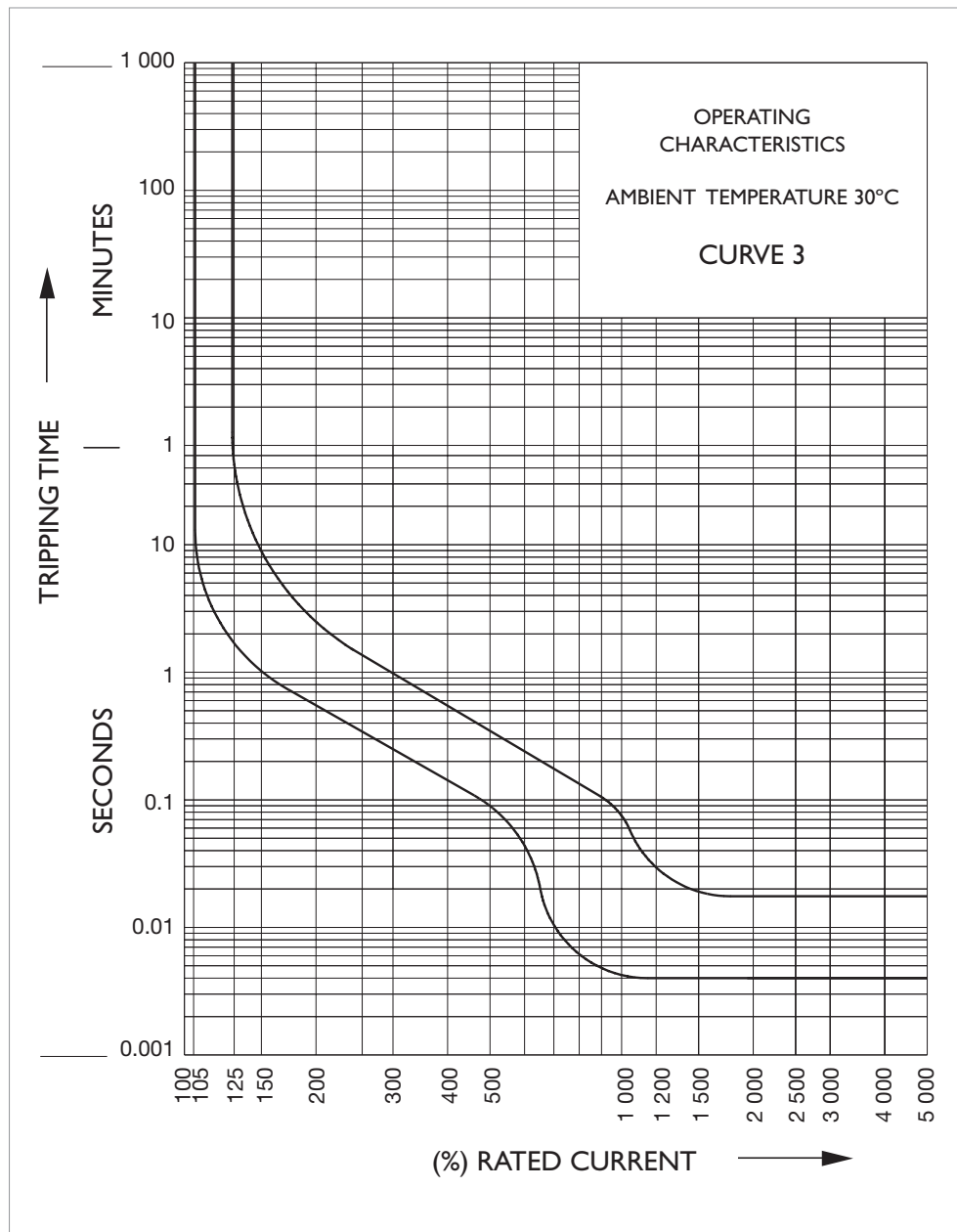



# HEINEMANN ELECTRIC PTY LTD

## SALES OFFICES

### Melbourne

Head Office  
Tel: +61 3 9560 3333  
Fax: +61 3 9562 0172  
Free Call: 180 077 0870  
Email: [heinelec@heinelec.com.au](mailto:heinelec@heinelec.com.au)  
[www.heinemannelectric.com.au](http://www.heinemannelectric.com.au)

### Sydney

Tel: +61 2 9808 3000  
Fax: +61 2 9809 6296  
Free Call: 180 077 0870  
Email: [hesyd@heinelec.com.au](mailto:hesyd@heinelec.com.au)

### Townsville

Tel: +61 7 4775 5300  
Fax: +61 7 4725 1029  
Free Call: 180 077 0870  
Email: [hetow@heinelec.com.au](mailto:hetow@heinelec.com.au)

### Newcastle

Tel: +61 2 4952 6653  
Fax: +61 2 4952 5020  
Free Call: 180 077 0870  
Email: [henew@heinelec.com.au](mailto:henew@heinelec.com.au)

### Brisbane

Tel: +61 7 3854 1646  
Fax: +61 7 3252 3055  
Free Call: 180 077 0870  
Email: [hebri@heinelec.com.au](mailto:hebri@heinelec.com.au)

### Perth

Tel: +61 8 9478 3341  
Fax: +61 8 9478 3501  
Free Call: 180 077 0870  
Email: [heper@heinelec.com.au](mailto:heper@heinelec.com.au)

### Adelaide

Tel: +61 8 8443 5344  
Fax: +61 8 8234 1023  
Free Call: 180 077 0870  
Email: [heade@heinelec.com.au](mailto:heade@heinelec.com.au)

## DISTRIBUTORS

### Hobart

**Electrical Agencies**  
Tel: +61 3 6273 1855  
Fax: +61 3 6273 1158  
Free Call: 180 077 0870  
Email: [elecag@bigpond.net.au](mailto:elecag@bigpond.net.au)

### Darwin

**Jewell Distributors Pty Ltd**  
Tel: +61 8 8947 0870  
Fax: +61 8 8947 0764  
Free Call: 180 077 0870  
Email: [jewell.distributors@bigpond.com](mailto:jewell.distributors@bigpond.com)

